



QUINT POWER Software

User manual

User manual

QUINT POWER Software

2017-07-25

Designation: UM EN QUINT POWER Software

Revision: 02

Order No.: —

This user manual is valid for:

Fourth generation QUINT POWER power supplies

Table of contents

1	For your safety	5
	1.1 Labeling of warning notes	5
	1.2 Qualification of users	5
	1.3 Product changes	5
2	Overview of functions	6
3	Setting up the software	7
	3.1 System requirements.....	7
	3.2 Software installation	7
4	Establishing a connection to the power supply	8
	4.1 Starting the software.....	8
	4.2 Main menu.....	9
	4.3 Selecting the language	9
	4.4 Reading data	10
	4.5 Loading a default profile	10
	4.6 Adapting the configuration.....	11
	4.7 Writing data	11
	4.8 Saving the profile.....	12
	4.9 Saving a log file	12
5	Device Data	13
	5.1 Device identification	13
	5.2 Applying write protection	13
	5.3 Removing write protection	14
	5.4 Forgotten your password?	14
6	Output Voltage	15
	6.1 Output voltage in no-load operation.....	15
	6.2 Parallel operation.....	16
	6.3 Lock button on front.....	16
7	Characteristics	17
	7.1 Output characteristic curves	17

8	Signaling	20
	8.1 Signal output Out 1	21
	8.2 Signal output Out 2	24
	8.3 Signal output Out 13/14	27
9	Control Input	29
	9.1 Open active	30
	9.2 Closed active	31
	9.3 Switch-on delay	32
	9.4 Switch-off delay	32
A	Appendixes	33
	A 1 List of figures	33
	A 2 List of tables	34

1 For your safety

Read this user manual carefully and keep it for future reference.

1.1 Labeling of warning notes



This symbol indicates hazards that could lead to personal injury. There are three signal words indicating the severity of a potential injury.

DANGER

Indicates a hazard with a high risk level. If this hazardous situation is not avoided, it will result in death or serious injury.

WARNING

Indicates a hazard with a medium risk level. If this hazardous situation is not avoided, it could result in death or serious injury.

CAUTION

Indicates a hazard with a low risk level. If this hazardous situation is not avoided, it could result in minor or moderate injury.



This symbol together with the **NOTE** signal word alerts the reader to a situation which may cause damage or malfunction to the device, hardware/software, or surrounding property.



Here you will find additional information or detailed sources of information.

1.2 Qualification of users

The use of products described in this user manual is oriented exclusively to:

- Qualified electricians or persons instructed by them. The users must be familiar with the relevant safety concepts of automation technology as well as applicable standards and other regulations.
- Qualified application programmers and software engineers. The users must be familiar with the relevant safety concepts of automation technology as well as applicable standards and other regulations.

1.3 Product changes

Changes or modifications to hardware and software of the device are not permitted.

Incorrect operation or modifications to the device can endanger your safety or damage the device. Do not repair the device yourself. If the device is defective, please contact Phoenix Contact.

2 Overview of functions

The QUINT POWER Software is a software tool for the individual configuration of fourth generation QUINT POWER power supplies.

Among other things, the software allows you to define signaling thresholds for preventive function monitoring, set the output voltage, and adapt the output characteristic curve to your specific requirements. Data transmission between the PC and power supply is by means of Near Field Communication (NFC).

Greater flexibility can be achieved by also installing the QUINT POWER App. This enables you to conveniently configure the power supply using a mobile terminal device.

By saving configuration profiles, you can archive your parameter data quickly and easily. In addition, you can send the configuration profiles by e-mail and conveniently switch between the software and app.

Features of the software

- Overview of all set parameters for the power supply
- Set customer-specific parameters
- Store and manage configuration profiles
- High degree of flexibility, thanks to data exchange with the QUINT POWER App



The software is intended for PCs. This user manual only describes the QUINT POWER Software. For mobile terminal devices, install the QUINT POWER App from the Google Play Store. For technical background information, refer to the data sheet at [phoenixcontact.net/products](https://www.phoenixcontact.net/products).

3 Setting up the software

In order to individually parameterize your power supply, you need to set up the software on a PC. Take the following system requirements into consideration:

3.1 System requirements

In order to configure the power supply via the NFC interface, the following hardware and software is required:

- PC or notebook (as of Windows 7, Microsoft.Net Framework 4.5, USB 2.0 interface, hard disk space used by the QUINT POWER Software: max. 50 MB)
- TWN4 MIFARE NFC USB ADAPTER programming adapter (Order No. 2909681)
- QUINT POWER Software programming software

3.2 Software installation



The QUINT POWER Software is available free of charge at phoenixcontact.net/catalog.

To install the software, proceed as follows:

1. Search for the QUINT POWER Software on the www.phoenixcontact.net/catalog page.
2. Download the QUINT POWER Software.exe file.
3. Save the QUINT POWER Software.exe file in the desired download folder.
4. Install the QUINT POWER Software from the selected download folder. Follow the instructions displayed on your PC monitor.
5. Carefully read through the EULA (End User License Agreement) when it is displayed on your monitor. Accept the terms of the agreement to proceed with installation.
6. Start the software (see Section 4.1, “Starting the software”).
7. Familiarize yourself with the software settings.

4 Establishing a connection to the power supply

The software visualizes the key technical data of your power supply on the PC. Use the software to read the parameters of a power supply or to create an individual profile for your power supply. Transfer the profile to other power supplies. Use this function for power supplies that are operated in parallel, for example. To do this, the software only needs to read the profile data once. The TWN4 MIFARE NFC USB ADAPTER transfers the relevant data to other power supplies. To do this, hold the TWN4 MIFARE NFC USB ADAPTER in front of the NFC interface of the individual power supplies. The interface is marked with the NFC symbol.



For data exchange via NFC, you must always switch your power supply off or to SLEEP MODE.

4.1 Starting the software

1. Start the software on your PC.

The start page appears on your monitor interface. Here, you have the possibility to read in a power supply. Alternatively, you can either start a new configuration by loading a standard profile, or open an already-saved configuration. Afterwards, you return automatically to the main menu.

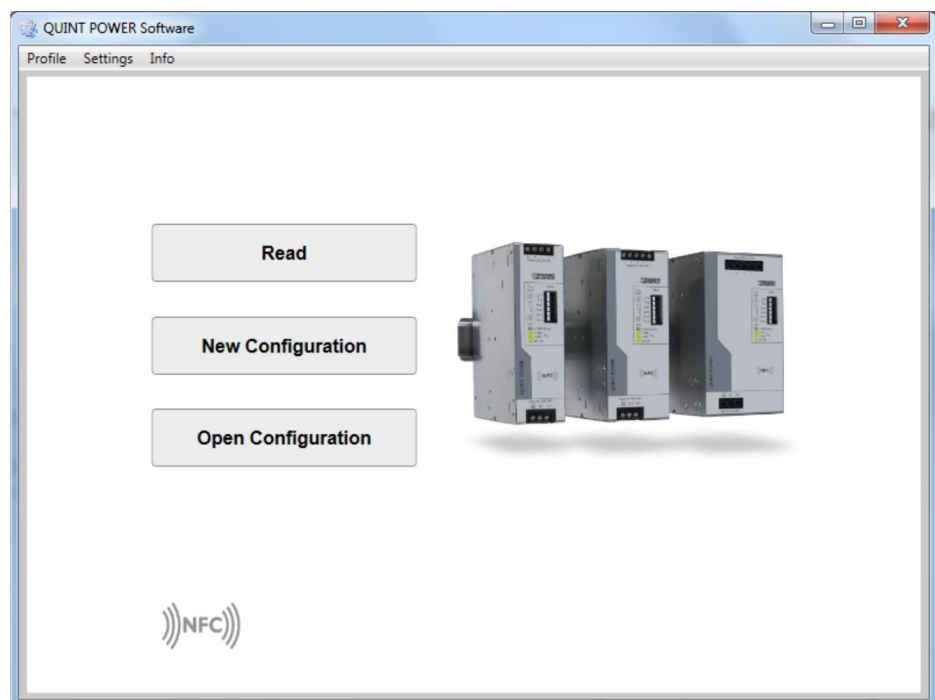

Figure 4-1 Start page

4.2 Main menu

A QUINT POWER power supply is shown in the middle of the interface. You can configure your power supply in the five categories: Device Data, Output Voltage, Characteristics, Signaling, and Control Input. For more detailed information on configuration, refer to the subsequent sections of this user manual.

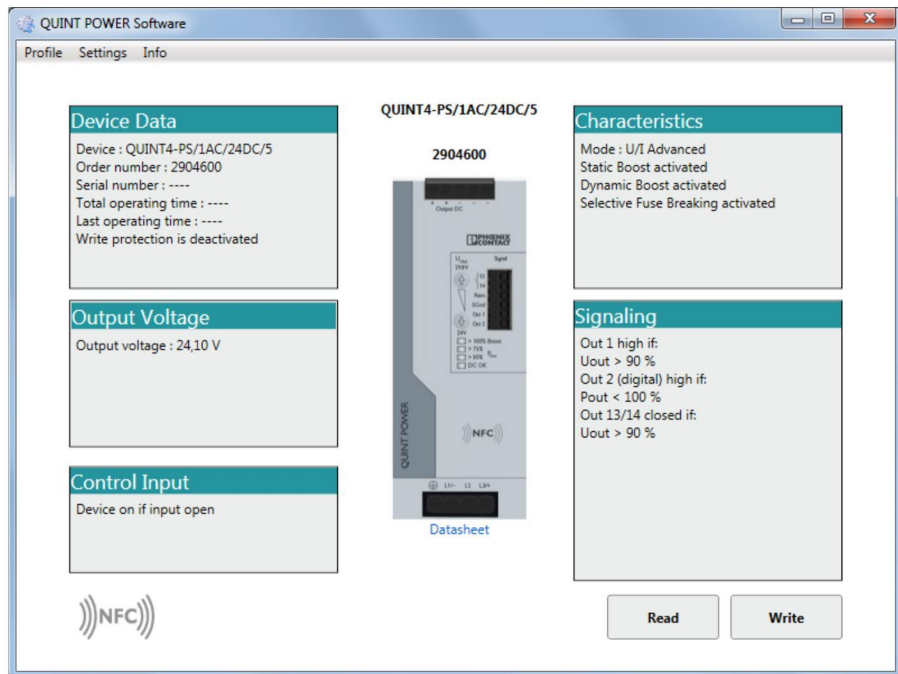

Figure 4-2 Main menu of the QUINT POWER Software

4.3 Selecting the language

First, set the language for the user interface.

1. In the menu bar, select “Settings”.
2. Set the language in the “Settings, Options” menu.
3. Confirm your entry with “OK”.



The software automatically saves the language settings. The next time the software is started, the user interface will be in the language that was last selected.

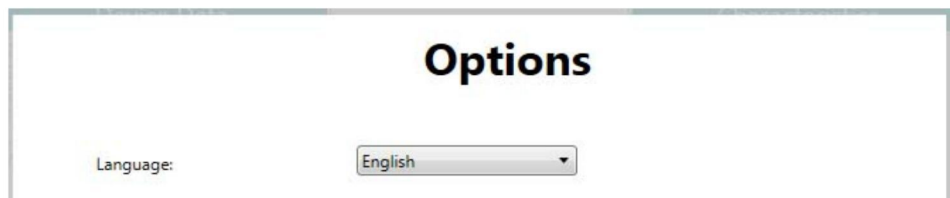

Figure 4-3 Selecting the language

4.4 Reading data

Use the TWN4 MIFARE NFC USB ADAPTER to read the data for your power supply.

1. Connect the TWN4 MIFARE NFC USB ADAPTER to the PC.
2. Switch the power supply off or to SLEEP MODE.
3. Start the software on your PC.
4. Click on the “Read” button. The green CONN LED signals that the adapter is ready for operation.
5. Hold the TWN4 MIFARE NFC USB ADAPTER in front of the NFC symbol on the power supply. Communication is established automatically and signaled by the flashing red DAT LED. The software reads the parameters of the power supply and visualizes them on your PC.

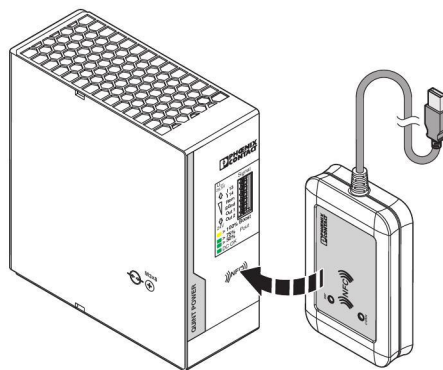

Figure 4-4 Reading the power supply data

4.5 Loading a default profile

You can create an individual profile for your power supply based on a default profile. Furthermore, you can reset your customized configuration to the default settings.

1. In the menu bar, open "Profile".
2. Select the device type in the "Profile, New Configuration" menu.
3. You can individually adapt the parameters of your power supply (see Section 4.6, "Adapting the configuration"). If you would like to reset your power supply to the default profile, skip this step.
4. Transfer the set data to the power supply (see Section 4.7, "Writing data").

4.6 Adapting the configuration

You can adapt a configuration to your requirements at any time.

1. Select a category in the main menu, e.g., "Output Voltage".
2. Edit the voltage for the power supply. Enter an output voltage between 23.9 V and 29.6 V in the corresponding input field.
3. Confirm your entry. Click the "OK" button.
4. If necessary, change any additional parameters.
5. Transfer the set data to the power supply (see Section 4.7, "Writing data").

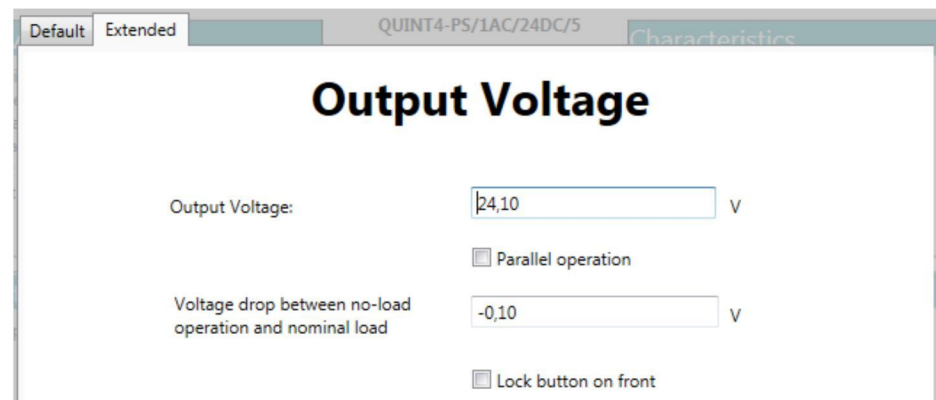

Figure 4-5 Adapting the output voltage

4.7 Writing data

If you have adapted the configuration or created an individual profile, transfer the data to the power supply.

1. Switch the power supply off or to SLEEP MODE.
2. Click on the "Write" button in the main menu.
3. Hold the TWN4 MIFARE NFC USB ADAPTER in front of the NFC symbol on the power supply. Communication is established automatically and signaled by the flashing red DAT LED. The data is transferred to your power supply via the NFC interface.

When parameterization is completed and you do not wish to make any further settings, you can switch the power supply on.

4.8 Saving the profile

If you would like to use your individual configuration to parameterize other power supplies, you can save and archive the profile.

1. In the menu bar, open "Profile".
2. Select the "Save configuration as..." function
3. Select a storage location on your PC.



The individual profile for your power supply is stored on your PC. You can access it again at any time as and when required.

4.9 Saving a log file

After every write operation the software saves the set parameters in an automatically generated log file. You can change the storage location of the log file as follows:

1. In the menu bar, open "Settings, Options".
2. Under "Path of Log-Files" select a storage location on your PC. To do this, click on the "..." button.
3. Now save your settings.

5 Device Data

The “Device Data” category shows the device-specific data for your power supply. Among other things, the “Total operating time” and the “Last operating time” are specified here. The “Total operating time” indicates the overall total number of operating hours of the power supply. The “Last operating time” indicates the number of operating hours of the power supply since it was last switched on.

Figure 5-1 “Device Data” category

5.1 Device identification

You have the option of assigning individual device identification for your power supply. To do so, enter your chosen text in the device identification field.

5.2 Applying write protection

As an option, you can apply write protection to the settings for your power supply.

1. To do this, enter a **password** in the “Enter password” input field.
2. Enter the password again in the “Repeat password” input field.
3. To activate write protection, click on the “Enable write protection” button.
4. Transfer the set data to the power supply (see Section 4.7, “Writing data”).

5.3 Removing write protection

If you wish to remove the write protection, proceed as follows:

1. Enter the password in the “Enter password” input field.
2. To deactivate write protection, click on the “Disable write protection” button.
3. Transfer the set data to the power supply (see Section 4.7, “Writing data”).

5.4 Forgotten your password?

If you have forgotten your password, proceed as follows:

1. In the main menu, click on the “Read” button. The green CONN LED signals that the adapter is ready for operation.
2. Hold the TWN4 MIFARE NFC USB ADAPTER in front of the NFC symbol on the power supply. Communication is established automatically and signaled by the flashing red DAT LED. The software reads the parameters of the power supply and visualizes them on your PC.
3. In the menu bar, open “Settings, Options”.
4. Activate the “Write memory dump file” check box.
5. Save your settings. Under “Path of Log-Files” select a storage location on your PC. To do this, click on the “...” button.
6. Click the “OK” button to exit the “Settings, Options” menu.
7. In the main menu, click on the “Write” button. The following window opens on your monitor:



Figure 5-2 Note about password entry

8. Click on the arrow button (←). This takes you back to the main menu. There is now a **.mem file** in the storage location you selected for the log file.
9. Send this file by e-mail to: DE-PS-Support@phoenixcontact.com

6 Output Voltage

In the “Output Voltage” category, you can individually adjust the output voltage of your power supply. Configure your power supplies for optimum use in parallel operation. In order to prevent manual changes to the voltage, lock the buttons on the front of the power supply.

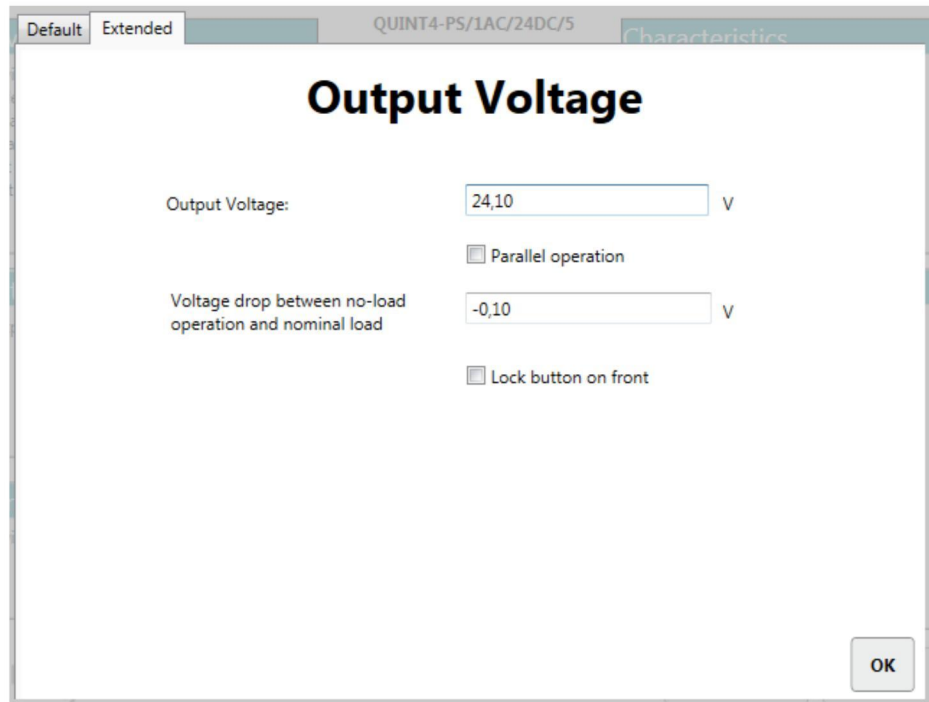

Figure 6-1 “Output Voltage” category

6.1 Output voltage in no-load operation

At this point, you can set the output voltage value in no-load operation. The smallest possible increment is 0.01 V.

6.2 Parallel operation

Power supplies of the same type can be connected in parallel for redundancy and to increase performance.

Activate the “Parallel operation” check box if you wish to connect your power supply in parallel.

In parallel operation, specify the voltage drop between no-load operation and nominal load as -0.5 V so as to ensure optimum current distribution.

If the “Parallel operation” check box is not activated, the voltage drop between no-load operation and nominal load is set to -0.1 V by default.

6.3 Lock button on front

There are two buttons on the front of the power supply, ↓(-), ↑(+). With these buttons, you can set the output voltage manually.

In order to avoid manual changes to the voltage, the software offers the option of locking the buttons. To do this, activate the “Lock button on front” check box.

7 Characteristics

Both the output characteristics and the overload behavior of the power supply can be individually adapted for special requirements.

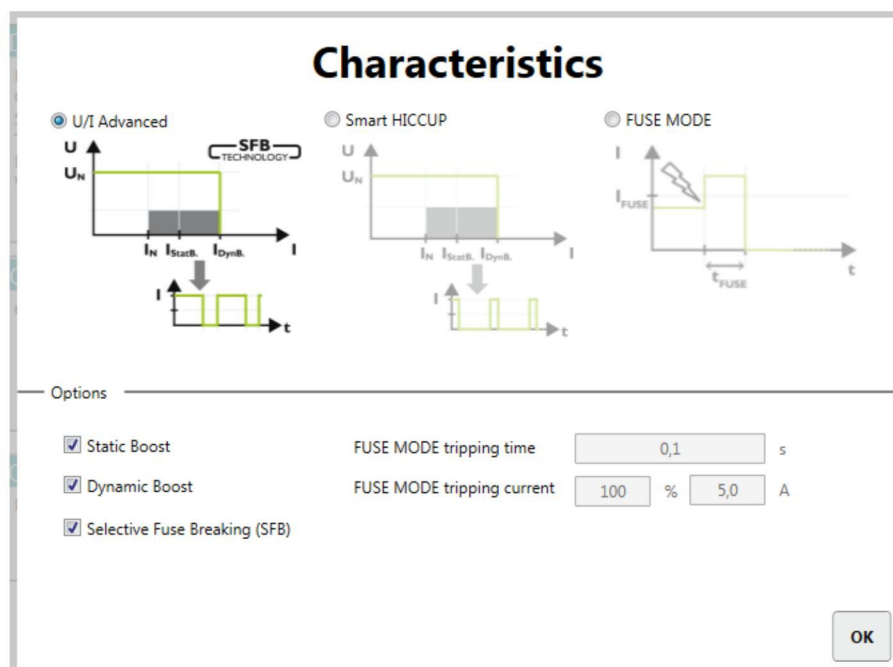

Figure 7-1 “Characteristics” category

7.1 Output characteristic curves

You can choose between three characteristic curves: **U/I Advanced**, **Smart HICCUP**, and **FUSE MODE**. This allows you to optimally adapt the power supply to the supplied load.

In the case of the **U/I Advanced** characteristic curve, you can deactivate and, if necessary, re-activate the static and dynamic Boost as well as SFB Technology. All three options are activated by default for this characteristic curve.

In the case of the **Smart HICCUP** characteristic curve, the static and dynamic Boost are activated by default. If required, you can deactivate and re-activate both options.

In the case of the **FUSE MODE** characteristic curve, the static Boost is activated by default. This can also be activated and re-activated if required.



The U/I Advanced output characteristic curve is set by default for your power supply.



For further information on the individual characteristic curves, refer to the data sheet for the QUINT POWER power supplies at [phoenixcontact.net/products](https://www.phoenixcontact.net/products).

7.1.1 Static Boost

You can disable or enable the static Boost by deactivating or activating the corresponding check box.

Please note that when you deactivate the static Boost, the dynamic Boost and SFB Technology will also be disabled at the same time.

7.1.2 Dynamic Boost

You have the option of disabling or enabling the dynamic Boost by deactivating or activating the corresponding check box.

Please note that when you disable the dynamic Boost, SFB Technology will also be disabled. Enabling the dynamic Boost also simultaneously activates the static Boost.

7.1.3 Selective Fuse Breaking (SFB)

You can disable or enable SFB Technology by deactivating or activating the corresponding check box.

Please note that when you enable SFB Technology, the static and dynamic Boost will be activated at the same time.

7.1.4 FUSE MODE tripping time (tFUSE)

The FUSE MODE tripping time can be set in the range from 0.0 to 12.0 seconds in increments of 0.05 seconds.

7.1.5 FUSE MODE tripping current (IFUSE)

The FUSE MODE tripping current is specified as a percentage value in the range from 25 % to 100 %. It can be set in increments of 1 %. The absolute tripping current is calculated automatically and displayed.

Example

Your power supply has a nominal output voltage of 24 V and supplies a nominal output current of 10 A. In order to compensate for the voltage drop over the cables, set the power supply output voltage to 26 V.

In the event of a short circuit, the power supply should shut down on the secondary side when the FUSE MODE tripping current is exceeded. The absolute threshold value is then calculated as follows:

Nominal output voltage:

$$U_N = 24 \text{ V}$$

Nominal output current:

$$I_N = 10 \text{ A}$$

Voltage set under "Output Voltage" category:

$$U_{\text{Set}} = 26 \text{ V}$$

Relative FUSE MODE tripping current:

$$I_{\text{Fuse, rel}} = 100 \%$$

Absolute FUSE MODE tripping current:

$$I_{\text{Fuse, abs}} = I_{\text{Fuse, rel}} \cdot \frac{U_N \cdot I_N}{U_{\text{Set}}} = 9.2 \text{ A}$$

8 Signaling

For preventive function monitoring, the power supply has two parameterizable switching outputs Out 1 and Out 2 as well as one floating and also freely parameterizable relay switching output Out 13/14. Out 1 and Out 13/14 are digital signal outputs. Out 2 can output an analog or digital signal.



Figure 8-1 “Signaling” category

8.1 Signal output Out 1

Output Out 1 is used as a **digital signal output** for preventive function monitoring. Different signal dependencies can be configured as required.

8.1.1 Signal options

Select a signal option from the listed parameters:

- Output voltage
- Output current
- Output power
- Operating hours
- Temperature OK
- Input voltage OK
- Overvoltage Protection (OVP)

Additional signal option for 3AC/24DC/10A and 3AC/24DC/20A devices:

- Phase monitoring

Signal state Out 1 changes:

- When the current **output voltage** exceeds a parameterizable threshold value
- When the current **output current** exceeds a parameterizable threshold value
- When the current **output power** exceeds a parameterizable threshold value
- When the device runtime (**operating hours**) exceeds a parameterizable threshold value
- As an early warning for excessive operating temperature ($> 60^{\circ}\text{C}$) (**Temperature OK**)
- If the input voltage of the power supply is interrupted for 10 ms or
- If the circuit inside the device for protecting against surge voltages is activated at the output (**Overvoltage Protection (OVP)**) or
- If one phase fails completely or the voltage difference between the phases is $> 10\%$ (**Phase monitoring**)

8.1.2 Threshold value

When you select the **output power**, **output voltage** or **output current** signal options, a relative threshold value is defined. You can specify the relative threshold value in increments of 1 %. The absolute threshold value is calculated automatically and displayed.

When you select the **operating hours** signal option, an absolute threshold value can be set. The operating hours can be specified in increments of 0.1 h.



For the life expectancy of the power supply, please refer to the data sheet at [phoenixcontact.net/products](https://www.phoenixcontact.net/products).

Output voltage

The threshold value for the output voltage can be parameterized in the range from 25% to 135 % of the output voltage currently set. Example 1 shows the calculation of the threshold value.

Example 1

The nominal output voltage of your power supply is 24 V. In order to compensate for the voltage drop over the cables, set the power supply output voltage to 25 V. To monitor the **output voltage**, select a relative threshold value of 90 %. The absolute value is calculated as follows:

Set output voltage:

$$U_{Set} = 25 \text{ V}$$

Relative threshold value:

$$U_{Th, rel} = 90 \%$$

Absolute threshold value:

$$U_{Th, abs} = U_{Th, rel} \cdot U_{Set} = 22.5 \text{ V}$$

Output current and output power

The setting ranges for the output current and output power threshold values depend on the device (see Table 8-1 “Setting range for output current and output power signaling”). The static Boost and dynamic Boost also influence the settings. You can set the static and dynamic Boost in the “Characteristics” category (see Section 7.1.1, “Static Boost” and Section 7.1.2, “Dynamic Boost”).

Table 8-1 Setting range for output current and output power signaling

	Dynamic Boost activated	Dynamic Boost deactivated
Devices with nominal power up to and including 240 W		
Static Boost activated	5 % to 200 %	5 % to 125 %
Static Boost deactivated		5 % to 100 %
Devices with nominal power greater than 240 W		
Static Boost activated	5 % to 150 %	5 % to 125 %
Static Boost deactivated		5 % to 100 %

The absolute threshold value for output current and output power is calculated automatically and displayed. Examples 2 and 3 show the calculation of the threshold value.

Example 2

The output power of your power supply is 240 W (24 V nominal output power, 10 A nominal output current). To monitor the **output power**, select a relative threshold value of 80 %. The absolute value is then calculated as follows:

Output power:

$$P_N = 240 \text{ W}$$

Relative threshold value:

$$P_{Th, rel} = 80 \%$$

Absolute threshold value:

$$P_{Th, abs} = P_{Th, rel} \cdot P_N = 192 \text{ W}$$

Example 3

Your power supply has a nominal output voltage of 24 V and supplies a nominal output current of 10 A. In order to compensate for the voltage drop over the cables, set the power supply output voltage to 25 V.

To monitor the **output current**, select a relative threshold value of 100 %. The absolute value is calculated as follows:

Nominal output voltage:

$$U_N = 24 \text{ V}$$

Nominal output current:

$$I_N = 10 \text{ A}$$

Voltage set under "Output Voltage" category:

$$U_{Set} = 25 \text{ V}$$

Relative threshold value:

$$I_{Th, rel} = 100 \%$$

Absolute threshold value for monitoring the output current:

$$I_{Th, abs} = I_{Th, rel} \cdot \frac{U_N \cdot I_N}{U_{Set}} = 9.6 \text{ A}$$

8.1.3 Output state

The signal output state is set to “High” or “Low”. The selected output state applies for as long as the defined conditions, consisting of **signal option** and **threshold value**, are met.

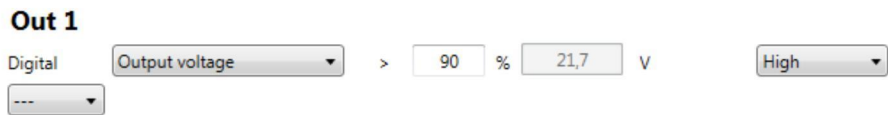

Figure 8-2 Output state Out 1

In the configuration, output state Out 1 is specified with “High”. This applies for as long as the output voltage is greater than 90 % of the set output voltage. If the output voltage falls below the 90 % value, output Out 1 changes to “Low”.

8.1.4 Linking two signal options

You can link two signal options together for preventive function monitoring. To do this, select the “Extended” tab and select the “ANDing” option in the corresponding drop-down menu.

8.2 Signal output Out 2

Output Out 2 is used as a **digital or analog signal output** for preventive function monitoring. Different signal dependencies can be configured as required.

8.2.1 Digital

Signal options

Select a signal option from the listed parameters:

- Output voltage
- Output current
- Output power
- Operating hours
- Temperature OK
- Overvoltage Protection (OVP)

Additional signal option for 3AC/24DC/10A and 3AC/24DC/20A devices:

- Phase monitoring

Signal state Out 2 changes:

- When the current **output voltage** exceeds a parameterizable threshold value
- When the current **output current** exceeds a parameterizable threshold value
- When the current **output power** exceeds a parameterizable threshold value
- When the device runtime (in **operating hours**) exceeds a parameterizable threshold value
- As an early warning for excessive operating temperature (> 60°C) (**Temperature OK**)
- If the circuit inside the device for protecting against surge voltages is activated at the output (**Overvoltage Protection (OVP)**)
- If one phase fails completely or the voltage difference between the phases is > 10 % (**Phase monitoring**)

Threshold value

When you select the **output power**, **output voltage** or **output current** signal options, a relative threshold value is defined. You can specify the relative threshold value with 1 % accuracy. The absolute threshold value is calculated automatically and displayed. The calculation of the absolute threshold values is equivalent to the calculation instructions provided in Section 8.1, "Signal output Out 1".

When you select the **operating hours** signal option, an absolute threshold value can be set. The operating hours can be specified in increments of 0.1 h.

Output state

The signal output state is set to "High" or "Low". The selected output state applies for as long as the defined conditions, consisting of **signal option** and **threshold value**, are met.

Linking two signal options

You can also link two signal options together for preventive function monitoring. To do this, select the "Extended" tab and select the "ANDing" option in the corresponding drop-down menu.

8.2.2 Analog

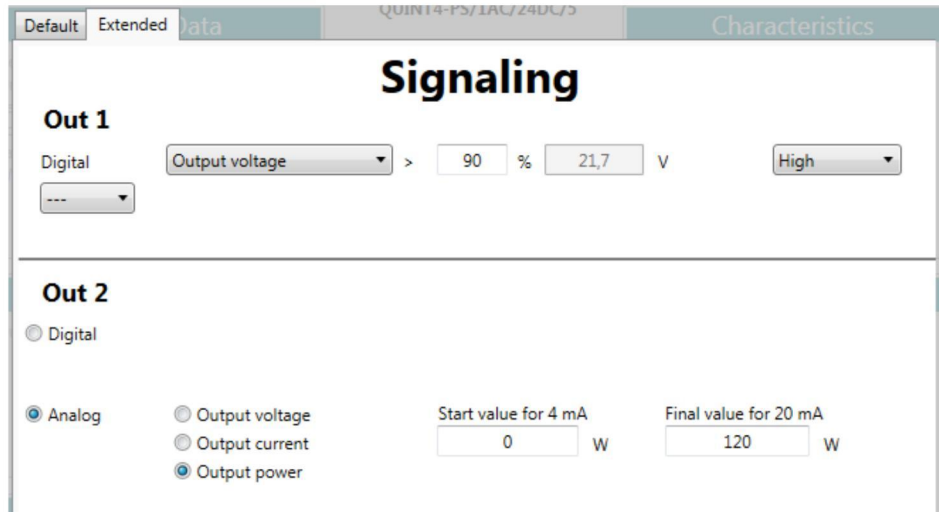

Figure 8-3 Analog signaling

Signal options

Connect the **output voltage**, **output current** or **output power** to the signal output as an analog signal in the range from 4 mA to 20 mA.

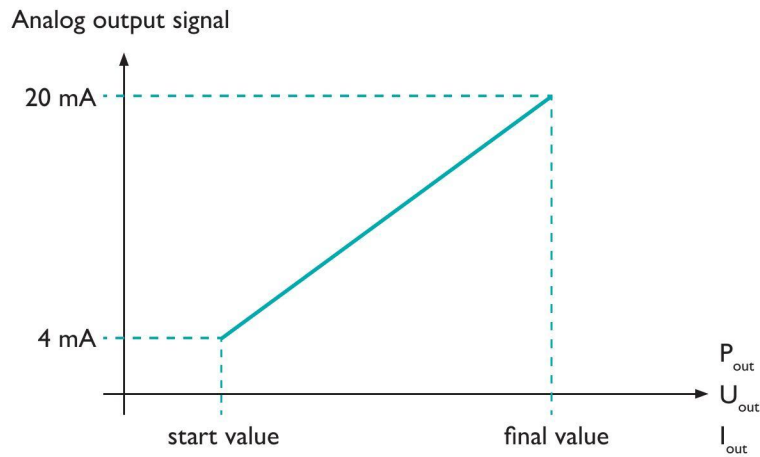

Figure 8-4 Analog output signal

The start value and final value of the analog output signal can be set between 4 mA and 20 mA. The setting range for these values depends on the signal option selected earlier.

Table 8-2 Start and final value setting ranges

Signal option	Device data			
	24 V / 5 A	24 V / 10 A	24 V / 20 A	48 V / 10 A
Output voltage	0 V to 32 V	0 V to 32 V	0 V to 32 V	0 V bis 60 V
Output current	0 A to 10 A	0 A to 20 A	0 A to 30 A	0 A bis 15 A
Output power	0 W to 240 W	0 W to 480 W	0 W to 720 W	0 W bis 720 W

8.3 Signal output Out 13/14

Floating relay contact Out 13/14 is also used for preventive function monitoring. Different signal dependencies can be configured as required.

8.3.1 Signal options

Select a signal option from the listed parameters:

- Output voltage
- Output current
- Output power
- Operating hours
- Temperature OK
- Input voltage OK
- Overvoltage Protection (OVP)

Additional signal option for 3AC/24DC/10A and 3AC/24DC/20A devices:

- Phase monitoring

Signal state Out 13/14 changes:

- When the current **output voltage** exceeds a parameterizable threshold value
- When the current **output current** exceeds a parameterizable threshold value
- When the current **output power** exceeds a parameterizable threshold value
- When the device runtime (in **operating hours**) exceeds a parameterizable threshold value
- As an early warning for excessive operating temperature (> 60°C) (**Temperature OK**)
- If the input voltage of the power supply is interrupted for 10 ms or
- If the circuit inside the device for protecting against surge voltages is activated at the output (**Overvoltage Protection (OVP)**) or
- If one phase fails completely or the voltage difference between the phases is > 10 % (**Phase monitoring**)

8.3.2 Threshold value

When you select the **output power**, **output voltage** or **output current** signal options, a relative threshold value is defined. You can specify the relative threshold value in increments of 1 %. The absolute threshold value is calculated automatically and displayed. The calculation of the absolute threshold values is equivalent to the calculation instructions provided in Section 8.1, “Signal output Out 1”.

When you select the **operating hours** signal option, an absolute threshold value can be set. The operating hours can be specified in increments of 0.1 h.

The threshold value for the output voltage can be parameterized in the range from 25 % to 135 %.

8.3.3 Output state

The signal output state is set to “closed” or “open”. The selected output state applies for as long as the defined conditions, consisting of **signal option** and **threshold value**, are met.



Figure 8-5 Output state Out 13/14

If the output voltage is greater than 90 % of the set output voltage, the relay contact for Out 13/14 is closed (see Figure 8-5 “Output state Out 13/14”). If the output voltage falls below this value, the contact opens.

Linking two signal options

You can link two signal options together for preventive function monitoring. To do this, select the “Extended” tab and select the “ANDing” option in the corresponding drop-down menu.

9 Control Input

The power supply is switched off on the secondary side via signal output Rem. The device is then in SLEEP MODE. When wiring the control input, a distinction is made between the “Open active” and “Closed active” states.

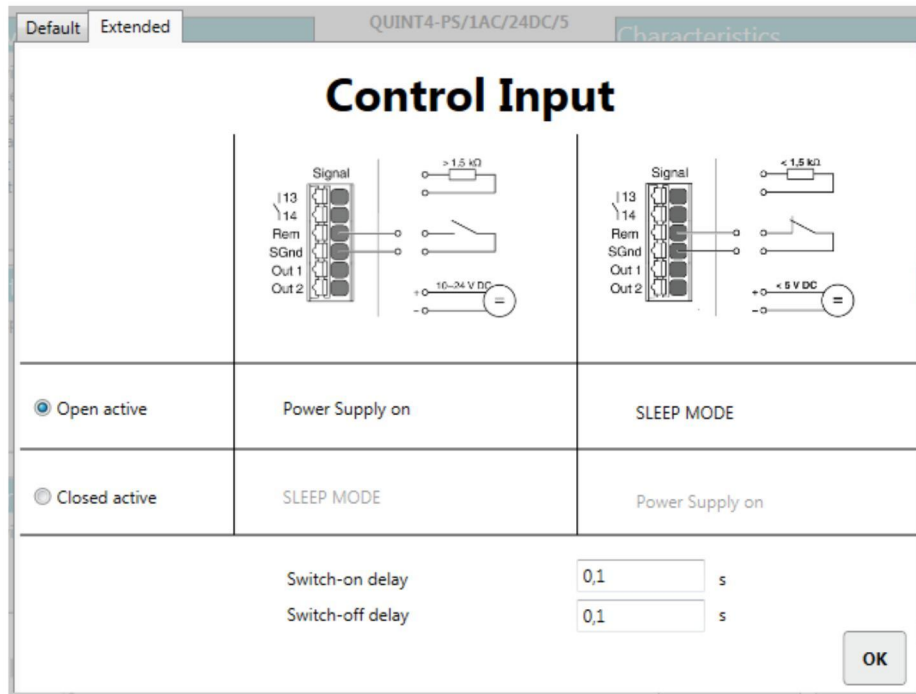

Figure 9-1 “Control Input” category

9.1 Open active

If the **Open active** radio button is activated, the **power supply is switched on** if:

- You connect a resistor greater than 1.5 kΩ between signal contacts Rem and SGnd
- Signal contacts Rem and SGnd are open or
- A voltage source is connected between signal contacts Rem and SGnd which supplies a voltage in the range from 10 V to 24 V DC

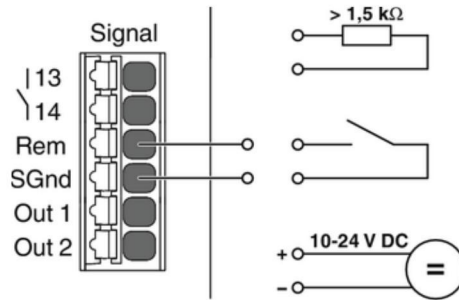

Figure 9-2 Open active – power supply ON

The **power supply** can be **switched off on the secondary side** if:

- You connect a resistor less than 1.5 kΩ between signal contacts Rem and SGnd
- Signal contacts Rem and SGnd are short circuited or
- A voltage source is connected between signal contacts Rem and SGnd which supplies a voltage in the range from 0 V to 5 V DC

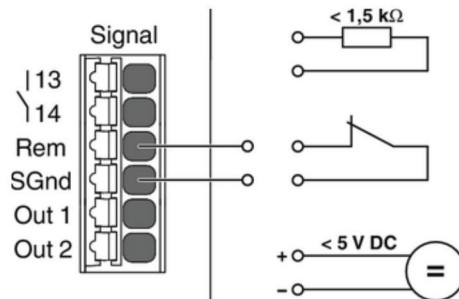

Figure 9-3 Open active – SLEEP MODE

9.2 Closed active

If the **Closed active** radio button is activated, the **power supply is switched on** if:

- You connect a resistor less than 1.5 k Ω between signal contacts Rem and SGnd
- Signal contacts Rem and SGnd are short circuited or
- A voltage source is connected between signal contacts Rem and SGnd which supplies a voltage in the range from 0 V to 5 V DC

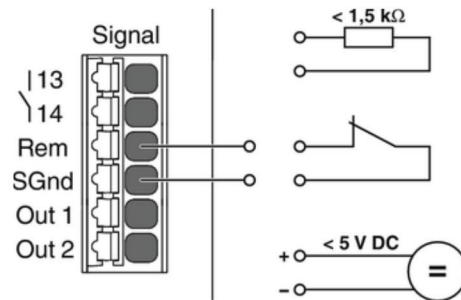

Figure 9-4 Closed active – power supply ON

The power supply can then be **switched off on the secondary side** if:

- You connect a resistor greater than 1.5 k Ω between signal contacts Rem and SGnd
- Signal contacts Rem and SGnd are open or
- A voltage source is connected between signal contacts Rem and SGnd which supplies a voltage in the range from 10 V to 24 V DC

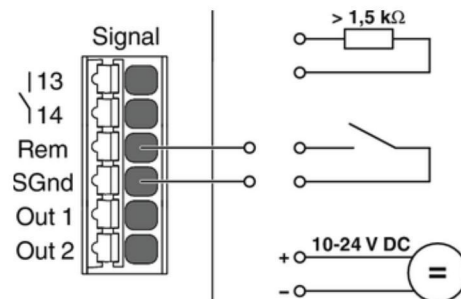

Figure 9-5 Closed active – SLEEP MODE

9.3 Switch-on delay

The switch-on delay for the control input can be set in the range from 0 to 12 seconds in increments of 0.1 seconds.

9.4 Switch-off delay

The switch-off delay for the control input can be set in the range from 0 to 12 seconds in increments of 0.1 seconds.

A Appendixes

A 1 List of figures

Section 4

Figure 4-1:	Start page	8
Figure 4-2:	Main menu of the QUINT POWER Software	9
Figure 4-3:	Selecting the language	9
Figure 4-4:	Reading the power supply data	10
Figure 4-5:	Adapting the output voltage	11

Section 5

Figure 5-1:	“Device Data” category	13
Figure 5-2:	Note about password entry	14

Section 6

Figure 6-1:	“Output Voltage” category	15
-------------	---------------------------------	----

Section 7

Figure 7-1:	“Characteristics” category	17
-------------	----------------------------------	----

Section 8

Figure 8-1:	“Signaling” category	20
Figure 8-2:	Output state Out 1	24
Figure 8-3:	Analog signaling	26
Figure 8-4:	Analog output signal	26
Figure 8-5:	Output state Out 13/14	28

Section 9

Figure 9-1:	“Control Input” category	29
Figure 9-2:	Open active – power supply ON	30
Figure 9-3:	Open active – SLEEP MODE	30
Figure 9-4:	Closed active – power supply ON	31
Figure 9-5:	Closed active – SLEEP MODE	31

A 2 List of tables

Section 8

Table 8-1:	Setting range for output current and output power signaling	22
Table 8-2:	Start and final value setting ranges	27

Please observe the following notes

General terms and conditions of use for technical documentation

Phoenix Contact reserves the right to alter, correct, and/or improve the technical documentation and the products described in the technical documentation at its own discretion and without giving prior notice, insofar as this is reasonable for the user. The same applies to any technical changes that serve the purpose of technical progress.

The receipt of technical documentation (in particular user documentation) does not constitute any further duty on the part of Phoenix Contact to furnish information on modifications to products and/or technical documentation. You are responsible to verify the suitability and intended use of the products in your specific application, in particular with regard to observing the applicable standards and regulations. All information made available in the technical data is supplied without any accompanying guarantee, whether expressly mentioned, implied or tacitly assumed.

In general, the provisions of the current standard Terms and Conditions of Phoenix Contact apply exclusively, in particular as concerns any warranty liability.

This manual, including all illustrations contained herein, is copyright protected. Any changes to the contents or the publication of extracts of this document is prohibited.

Phoenix Contact reserves the right to register its own intellectual property rights for the product identifications of Phoenix Contact products that are used here. Registration of such intellectual property rights by third parties is prohibited.

Other product identifications may be afforded legal protection, even where they may not be indicated as such.

How to contact us

Internet

Up-to-date information on Phoenix Contact products and our Terms and Conditions can be found on the Internet at:

phoenixcontact.com

Make sure you always use the latest documentation.

It can be downloaded at:

phoenixcontact.net/products

Subsidiaries

If there are any problems that cannot be solved using the documentation, please contact your Phoenix Contact subsidiary.

Subsidiary contact information is available at phoenixcontact.com.

Published by

PHOENIX CONTACT GmbH & Co. KG

Flachsmarktstraße 8

32825 Blomberg

GERMANY

PHOENIX CONTACT Development and Manufacturing, Inc.

586 Fulling Mill Road

Middletown, PA 17057

USA

Should you have any suggestions or recommendations for improvement of the contents and layout of our manuals, please send your comments to:

tecdoc@phoenixcontact.com